

EP type batteries are made in AGM technology and are constructed by plates, separators, safety valves and a container. Since the electrolyte is held by a glass-mat separator and plates, the batteries can be used in any chosen position without the risk of leakage. EP type batteries have a pressure relief valves that allows safe dispersal of any excess pressure inside the cell (VRLA). Due to advantages as sealed construction, maintenance free, low internal resistance and long term storage, EP batteries are the base of the emergency power supplying.



TECHNICAL DATA

Nominal voltage	6 V	
Nominal capacity	1,2 Ah / C ₂₀	
Cell per unit	3	
Technology	AGM	
Design life	6~9 years @ 20°C*	
	5 years @ 25°C	
Dimensions	height	56,0 mm
	length	97,0 mm
	width	25,0 mm
Weight	~0,3 kg	
Capacity @ 25°C	20h	60mA @1,75V/cell
	10h	114mA @1,75V/cell
	5h	204mA @1,75V/cell
	1h	787mA @1,60V/cell
Ambient nominal temperature range	charge	0°C ~ 40°C
	discharge	-20°C ~ 50°C
	storage	-20°C ~ 40°C
Internal resistance	@ fully charge battery	≤55 mΩ
Charging voltage @ 20°C	standby use	6,75V to 6,9V (-9 mV/°C)
	cycle use	7,2 V to 7,5V (-12 mV/°C)
Charging current	recommended	0,12 A
	maximum	0,36 A
Maximum discharge current (for 5 sec)	18 A	
Capacity retention during storage @ 20°C (self discharge)	after 1 month	97 %
	after 6 months	80 %
	after 12 months	63 %
Container material	standard	ABS UL 94-HB
	optional	ABS UL 94-V0**
Terminal	faston F1	T1
Terminal hardware initial torque	-	

- uninterruptible power supplies (UPS)
- emergency lighting systems
- telecommunication PABX
- cash registers and fiscal printers
- fire and security systems
- solar powered systems
- medical equipment
- mobile and portable equipment – cycle use
- measuring devices

DIMENSIONS

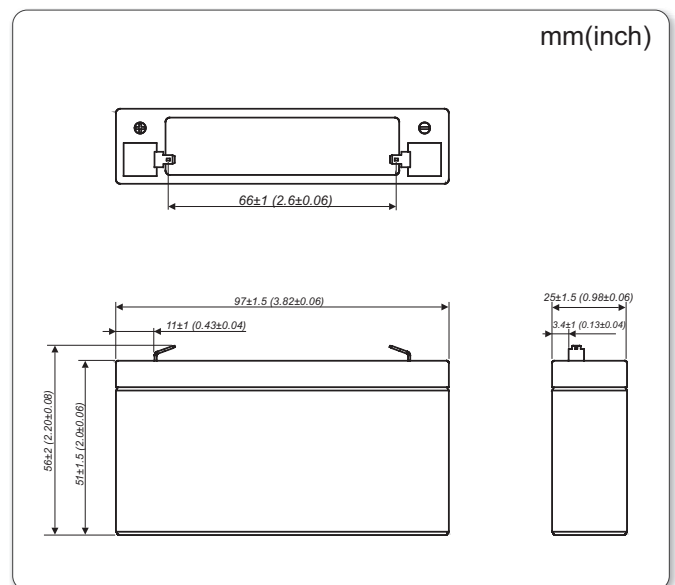

TERMINALS

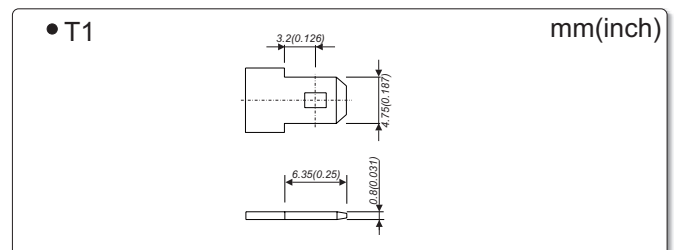

*) - According to Eurobat (General Purpose group) **) - Flame-retardant

NO TRANSPORT RESTRICTED

Not restricted for air, surface and water transport. Classified as non-hazardous material (IATA/ICAO Special Provision A67, DOT-CFR Title 49 parts 171-189, IMDG amendment 27)

DISCHARGE CHARACTERISTICS

• Constant current (Current [A], 25°C / 77°F)

F.V. V/cell	Discharge time										
	5 min	10 min	15 min	30 min	50 min	1hr	2hr	4hr	6hr	8hr	10hr
1,80	3,909	2,812	2,226	1,291	0,851	0,734	0,400	0,235	0,174	0,135	0,112
1,75	4,607	3,046	2,328	1,340	0,879	0,756	0,410	0,239	0,176	0,137	0,114
1,70	4,895	3,155	2,400	1,370	0,896	0,770	0,416	0,241	0,177	0,138	0,115
1,65	5,115	3,231	2,455	1,389	0,907	0,779	0,420	0,242	0,178	0,138	0,115
1,60	5,284	3,296	2,504	1,403	0,916	0,787	0,423	0,243	0,178	0,139	0,115
1,50	5,496	3,362	2,554	1,417	0,926	0,794	0,426	0,244	0,178	0,139	0,115

• Constant power (Power [W/cell], 25°C / 77°F)

F.V. V/cell	Discharge time										
	5 min	10 min	15 min	30 min	50 min	1hr	2hr	4hr	6hr	8hr	10hr
1,85	6,63	5,71	4,97	4,04	2,39	1,74	1,394	0,978	0,772	0,565	0,456
1,80	7,23	6,12	5,32	4,27	2,54	1,83	1,456	1,018	0,800	0,583	0,469
1,75	8,37	6,94	5,77	4,46	2,63	1,89	1,499	1,048	0,821	0,595	0,478
1,70	8,89	7,28	5,97	4,60	2,69	1,93	1,526	1,064	0,832	0,600	0,482
1,65	9,29	7,54	6,12	4,71	2,73	1,96	1,545	1,073	0,839	0,604	0,484
1,60	9,60	7,74	6,24	4,80	2,76	1,98	1,560	1,085	0,846	0,608	0,486

F.V. - Final voltage

Battery life characteristics of standby use

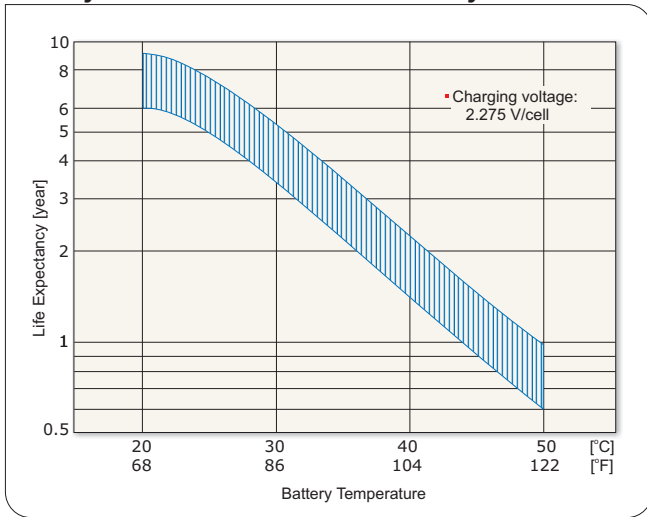

Battery life characteristics of cycle use

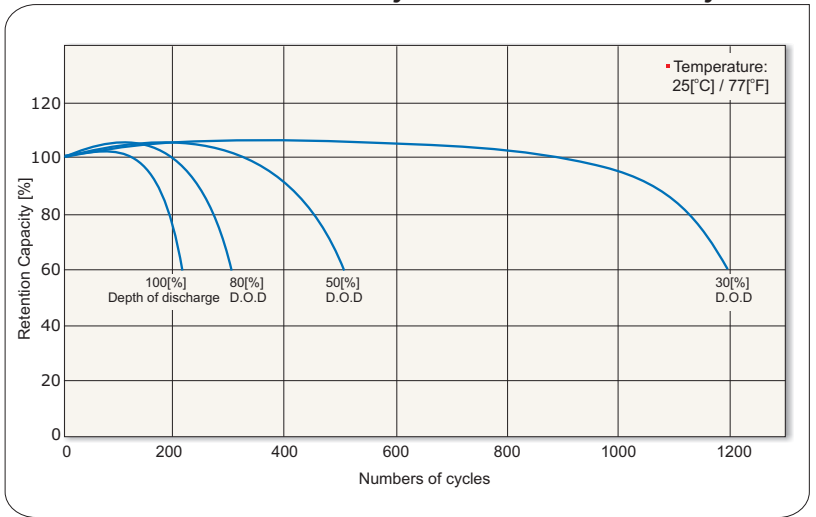

Battery discharge characteristics

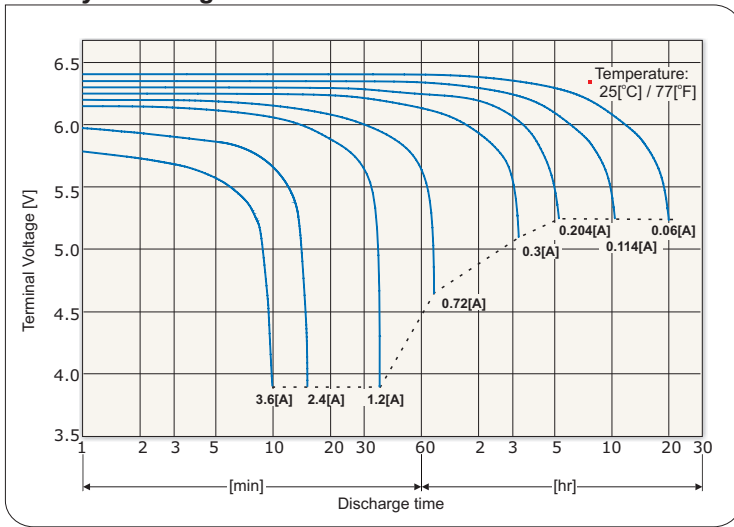

Battery self discharge characteristics

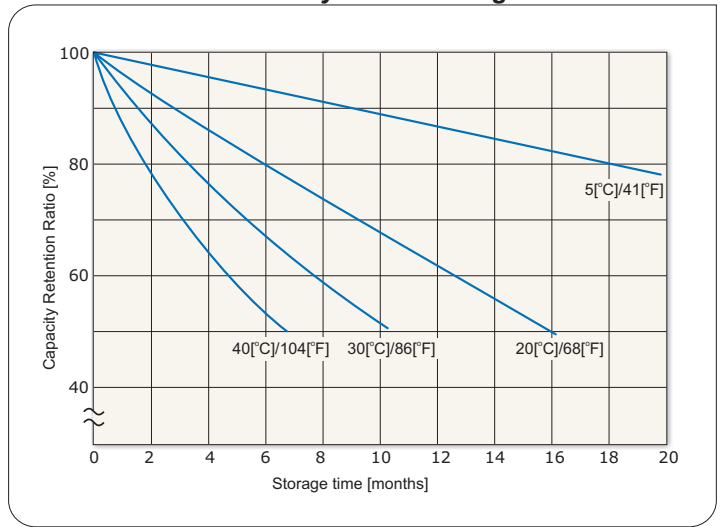

Battery charging characteristics for the standby use

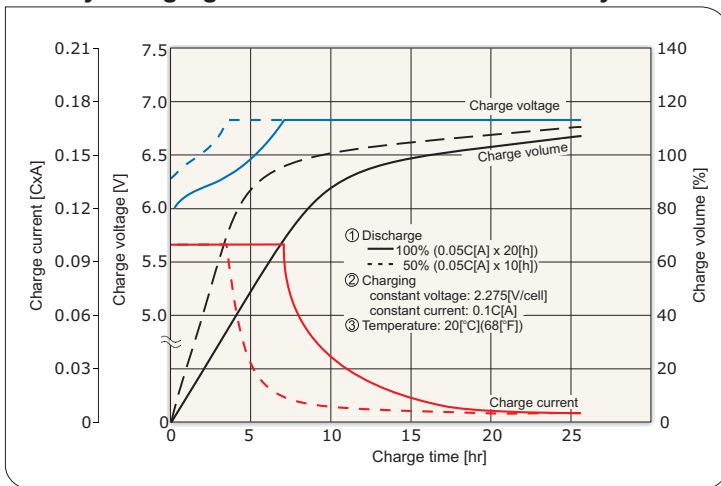

Battery charging characteristics for the cycle use

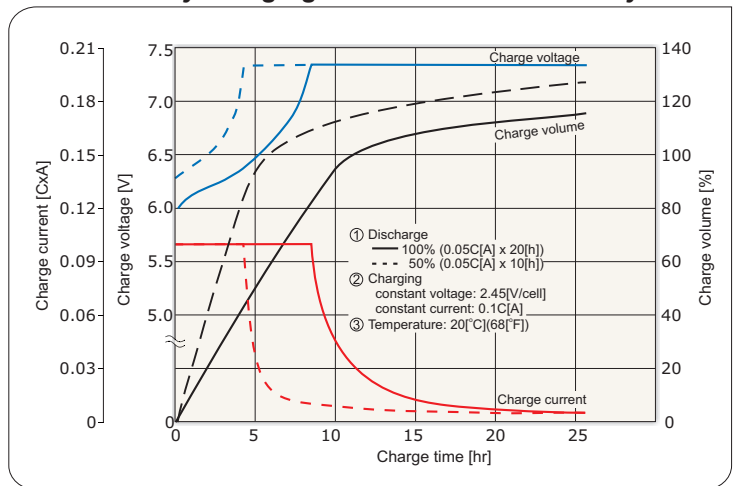

Battery discharge current and final discharge voltage

Discharge current [A]	0.24 > I	0.24 ≤ I < 0.6	0.6 ≤ I < 1.2	1.2 ≤ I
Final discharge voltage [V/cell]	1.75	1.70	1.55	1.30



*) C - Capacity